

## DRIVER AND EVENT DETAILS

Name **Terry Hill**  
 Date **10/02/2008**  
 Event \_\_\_\_\_  
 Weather \_\_\_\_\_  
 Result **Q 4th (A), Finished 7th & 10th**

## CHASSIS AND ELECTRICS

Chassis **Kr**  
 Top Deck  Flex  Standard  Stiff   
 Bodyshell **PF Mazda Speed Six**  
 Wing **Kr**  
 E.S.C. **Miracra IP6**  
 Servo **S9550**  
 Receiver \_\_\_\_\_  
 Number of Cells  4  5  6  
 Type of Cells **EP4500**

## TRACK CONDITIONS

Grip Level  High  Medium  Low   
 Track Type  Tight  Open  Both   
 Surface  Carpet  Tarmac  Wood   
 Venue  Indoor  Outdoor   
 Track Condition  Smooth  Bumpy   
 Track Temperature \_\_\_\_\_ °C \_\_\_\_\_ °F

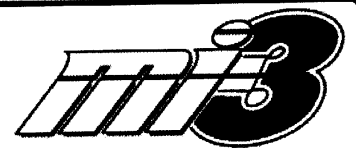

## DRIVER NOTES

0.5mm against wheel. Euro top deck used

## MOTOR AND GEARING

Type  Brushed  Brushless   
 Motor **Checkpoint**  
 Brush **Infinity**  
 Spring **+ m/h - m**  
 Timing \_\_\_\_\_  
 Gear Pitch  48Dp  64Dp   
 Spur Size **89**  
 Pinion Size **31**

## WHEELS, TYRES AND INSERTS

Wheels **LRP VTEC 27**  
 Tyres \_\_\_\_\_  
 Inserts \_\_\_\_\_  
 Tyre Additive **WESTWOOD**  
 Additive Time  MIN (R)  MIN (F)  
 Tyre Warmers  Yes  No

## FRONT SETTINGS

Drive  Diff  Spool  One-Way  Height  High  Low

Servo Saver  Yes  No   
 Toe In-Out  In-board  Out-board  1 ° Toe-out  
 Screw Block Spacers **Front 1** mm **Rear 0.5** mm  
 Wishbone Quik-Klips **Front 2** mm **Rear 2** mm  
 Link Washers (Horizontal) **3** mm  
 Ride Height (Chassis to Floor) **5** mm  
 Droop (Chassis to Floor) **5 ON GAUGE** mm  
 Anti-roll Bar  Yes  No  1.20  1.40  1.60   
 Castor  0°  2°  4°  6°   
 Camber  Positive  Negative  4 Deg  
 Link Washers (Vertical) **2** mm  
 Inboard Pin  Kick-up  Anti-dive  Horizontal   
 Pivot Block Spacers **Front 1** mm **Rear 1** mm

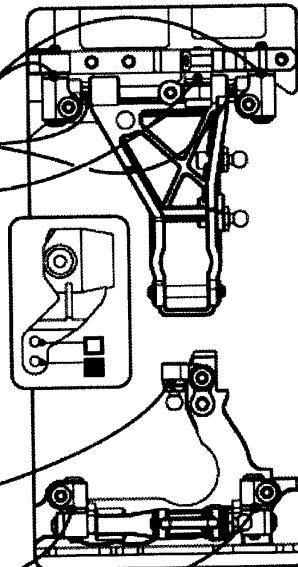

## Front Shocks

Oil **40** WT  
 Springs **HPI SILVER**  
 Piston Holes  2  3   
 length \_\_\_\_\_  
 Rebound \_\_\_\_\_ %

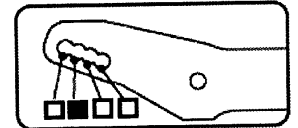
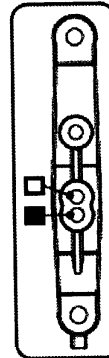

## Centre Track Rod

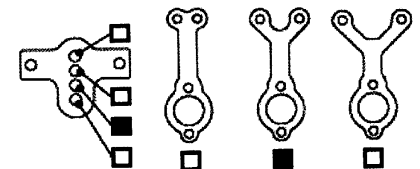

## REAR SETTINGS

Drive Height  High  Low

Toe In  In-board  Out-board  1 °  
 Screw Block Spacers **Front 2** mm **Rear 0.5** mm  
 Wishbone Quik-Klips **Front 2** mm **Rear 2** mm  
 Link Washers (Horizontal) **3** mm  
 Ride Height (Chassis to Floor) **5.5** mm  
 Droop (Chassis to Floor) **4 on gauge** mm  
 Anti-roll Bar  Yes  No  1.20  1.40  1.60   
 Camber  Positive  Negative  Deg  
 Link Washers (Vertical) **2** mm  
 Inboard Pin  Pro-Squat  Anti-Squat  Horizontal   
 Pivot Block Spacers **Front 2.5** mm **Rear 2.5** mm

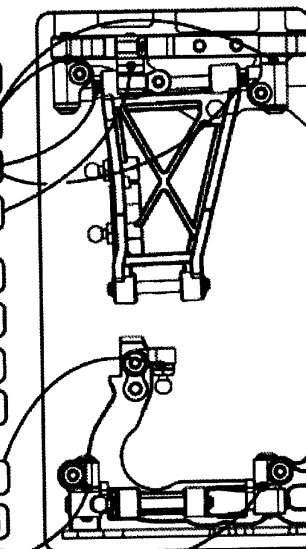

## Rear Shocks

Oil **30** WT  
 Springs **HPI BLUE**  
 Piston Holes  2  3   
 length \_\_\_\_\_  
 Rebound \_\_\_\_\_ %

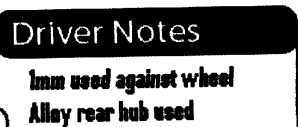
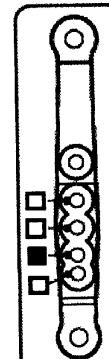

## Driver Notes

1mm used against wheel  
 Alloy rear hub used

