



Name \_\_\_\_\_

Date \_\_\_\_\_

Event \_\_\_\_\_

Composition  Asphalt  Indoor Surface  Smooth  Medium  Bumpy Layout  Tight  Mixed  Open Humidity \_\_\_\_\_  
 Carpet  Outdoor Traction  Low  Medium  High Track temp. \_\_\_\_\_ Air temp. \_\_\_\_\_

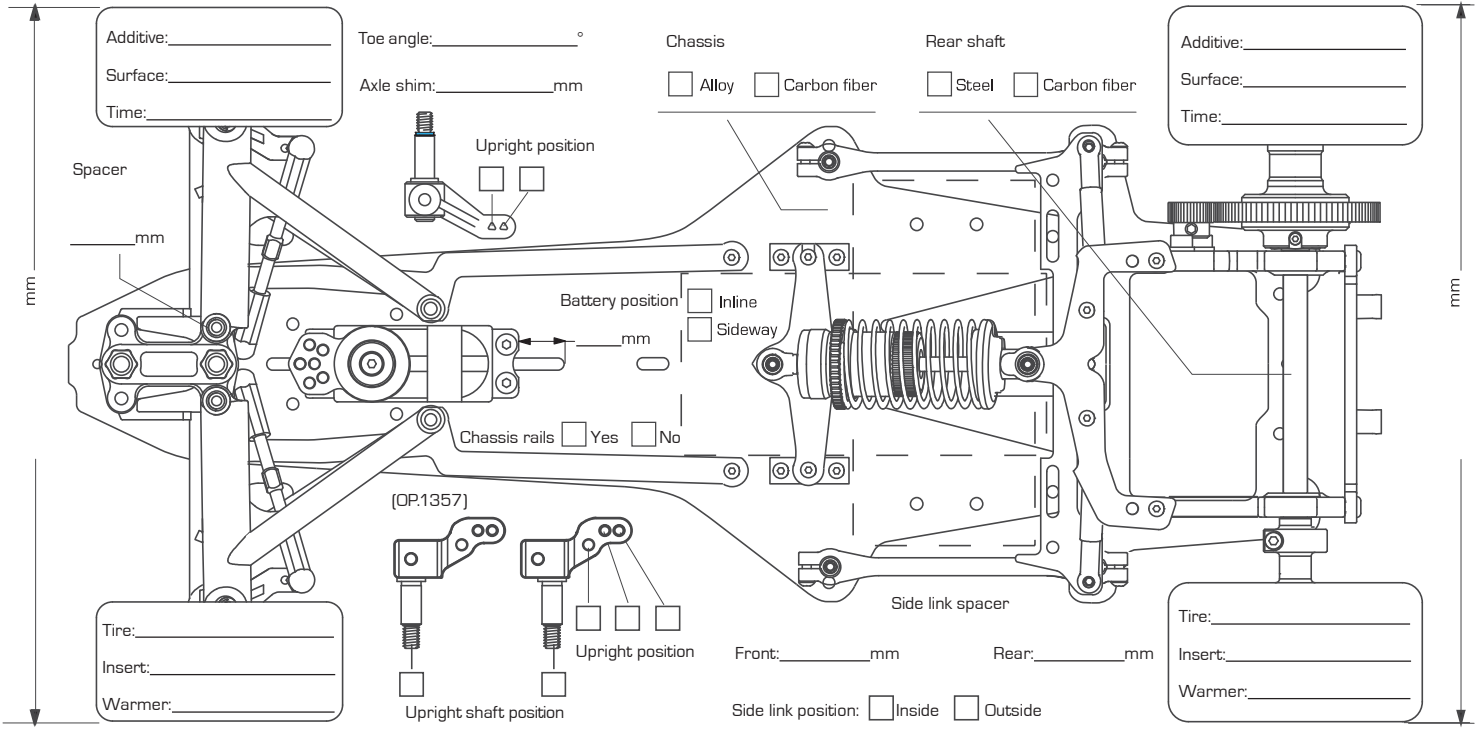

Belt:  Yes  No

Castor: \_\_\_\_\_ °

Spacer: \_\_\_\_\_ mm

Spacer: \_\_\_\_\_ mm

Wheelbase:  Short  Long

Camber: \_\_\_\_\_ °

Camberlink:  Short  Long

Camberlink shims: \_\_\_\_\_ mm

Spring: \_\_\_\_\_

Ackermann: \_\_\_\_\_

Front



Ground clearance: \_\_\_\_\_ mm

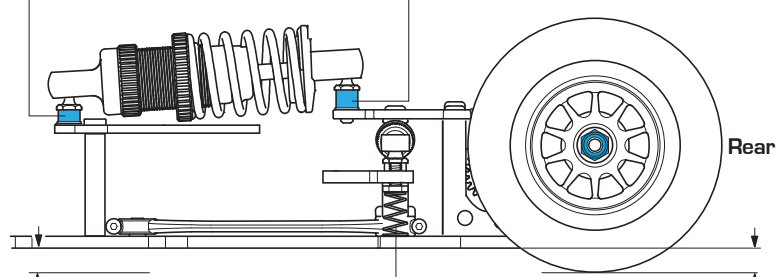

Roll spring: \_\_\_\_\_

Preload - L: \_\_\_\_\_ - R: \_\_\_\_\_

Ground clearance: \_\_\_\_\_ mm

Droop: \_\_\_\_\_ mm

Diff grease: \_\_\_\_\_

Bearing:  Standard  Thrust

**IFS Front**

Droop: \_\_\_\_\_ mm

Damper oil: \_\_\_\_\_ cst

Spring:  Hard  Soft

Shock tower hole:

Bottom  Middle  Top

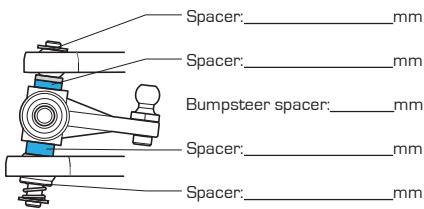

**Rear Ground Clearance**

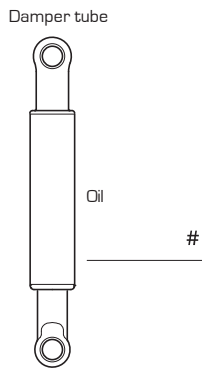
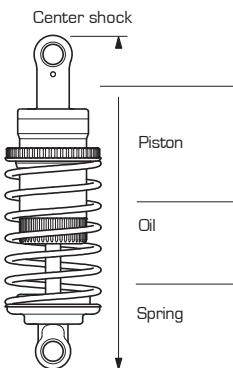
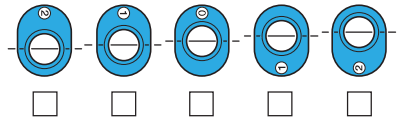
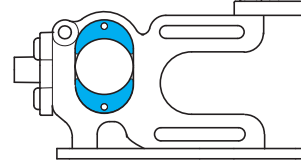

Notes

Motor: \_\_\_\_\_

Timing: \_\_\_\_\_

Spur/Pinion: \_\_\_\_\_

ESC: \_\_\_\_\_

ESC Setting: \_\_\_\_\_

Battery: \_\_\_\_\_

Body: \_\_\_\_\_

Front wing: \_\_\_\_\_

Front wing setting: \_\_\_\_\_

Rear wing: \_\_\_\_\_

Rear wing height: \_\_\_\_\_

Rear wing setting: \_\_\_\_\_

**Notes**