

ULTIMATE RB5

SET UP SHEET



Name

Glen Bean

Date

S-5-07

Truck / City

Evid RC Speedway

Event

Front Suspension



Upper Spacer
1 mm

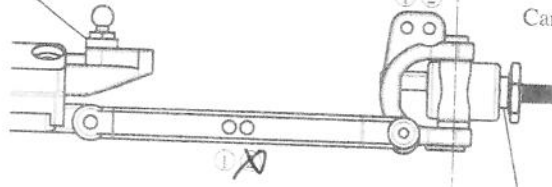

Camber + - 1°

Bump Steer Spacer
1 mm

Axle Height
 Up
 Down

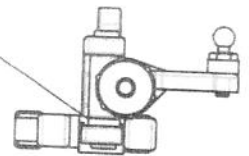

Toe In Out 0°

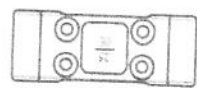

Caster
 25°
 30°
Spacer
 0.5
 1.0
 None

Axle Spacer
 In (Opt)
 Out (Standard)

Rear Suspension

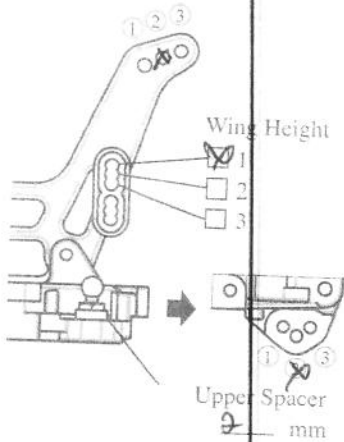

Wing Height
 1
 2
 3

Upper Spacer
2 mm

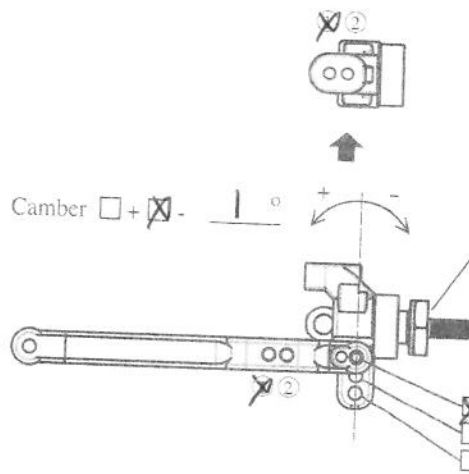

Camber + - 1°

Upper Spacer
2 mm

Wheel Spacer
mm

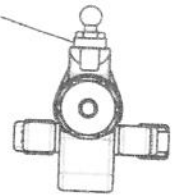

Wheelbase
 Long
 Middle
 Short

Rear Hub
 0° (Standard)
 0.5° (Opt.)

Anti-Squat _____ ° Sway Bar None mm

Shock

	Front	Rear
Shock Piston	<u>2 B</u>	<u>2 - B</u>
Shock Oil	<u># 32.5</u>	<u># 27.5</u>
Shock Spring	<u>ORANGE #55</u>	<u>YELLOW #65</u>
Limiters	<u>1mm</u>	<u>1mm</u>
Shock Length	mm	mm

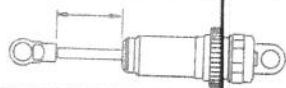

Body / Wing / Chassis

Body Kit
Wing Kit
Wing Angle
4° 7° 10°
Battery Placement
 Front Rear

Weight Placement

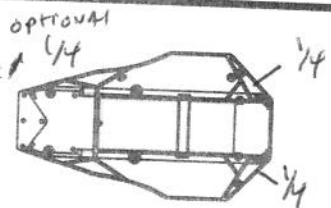

Ride Height A B F mm R mm

Tire

	Front	Rear
Tire	<u>Pink Tappers</u>	<u>pink x-3000</u>
Inserts	<u>Full rear</u>	<u>Trinity Bankers</u>
Wheel	<u>Kit</u>	<u>Kit</u>
Traction Compound	<u>Buggy Grip</u>	<u>Buggy Grip</u>

Others

Motor 13 x 2
Pinion/Spur 30 / 78
Battery _____
ESC _____

Truck Condition

Smooth Wet Blue Groove
 Bumpy Dry 2 Lay
 Low Traction Sandy Dusty
 Med. Traction Soft Dirt Other
 High Traction Grass

Comment: new track record. New Fast Lap. 19.1sec.